

+DIA-SR12
Set-Collar



TECHNICAL DETAILS

Material	Aluminium (ground)
Surface	● black, ● red, ● blue, ● green ● gold, ● ESD
Positional Tolerance Fitting Bores	± 0,01 mm
Positional Tolerance Bores	± 0,1 mm

MODULE DESCRIPTION

Accurate set-up of heights, in order to ensure precise attachment of mono or dual modules or other elements to the intended position.

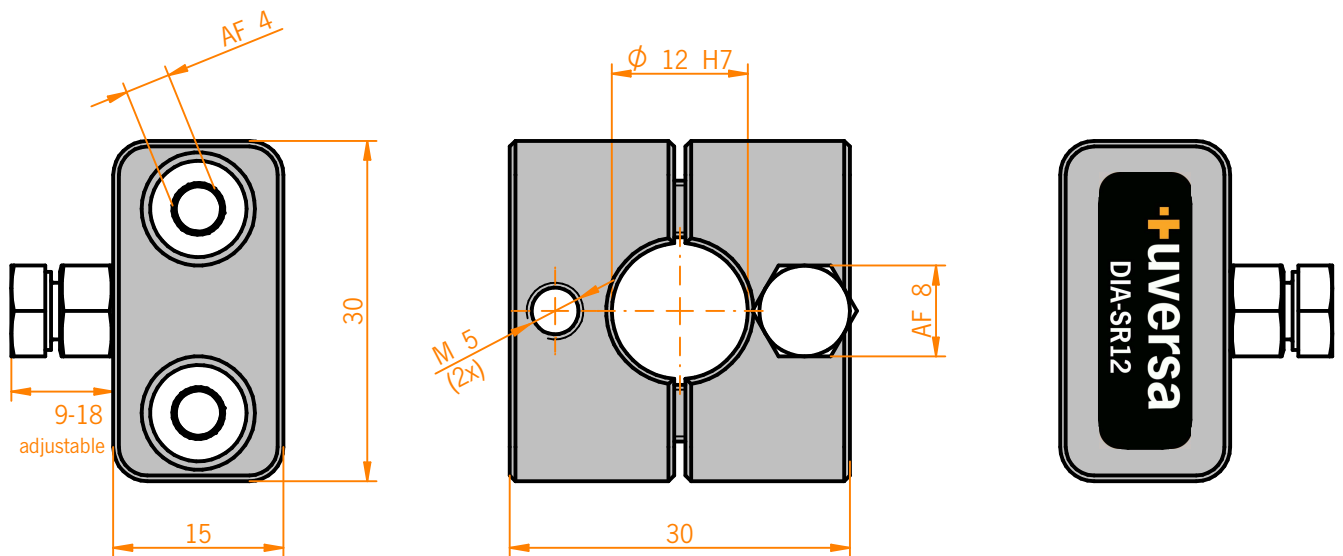

Customized items are available upon request.