

+EVO-DM30
Dual-Module



TECHNICAL DETAILS

Material	Aluminium (ground)
Surface	● black, ● red, ● blue, ● green ● gold, ● ESD
Positional Tolerance Fitting Bores	± 0,01 mm
Positional Tolerance Bores	± 0,1 mm

MODULE DESCRIPTION

Module with fitting and mounting bores for precise attachment of components in position. The two-piece structure enables the element quickly to be mounted to a two-column system also at a later date.

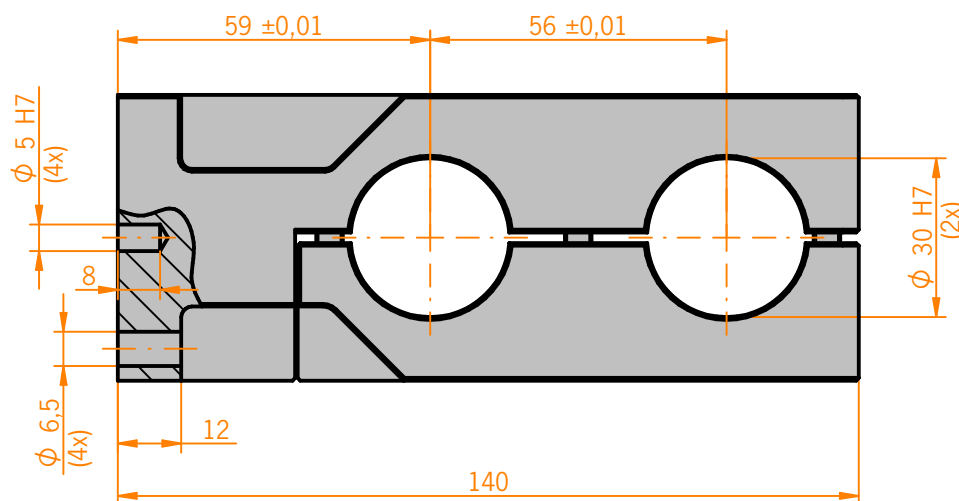
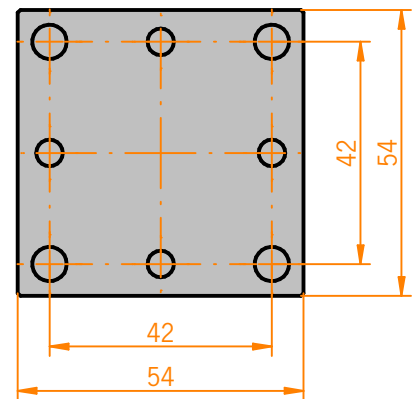
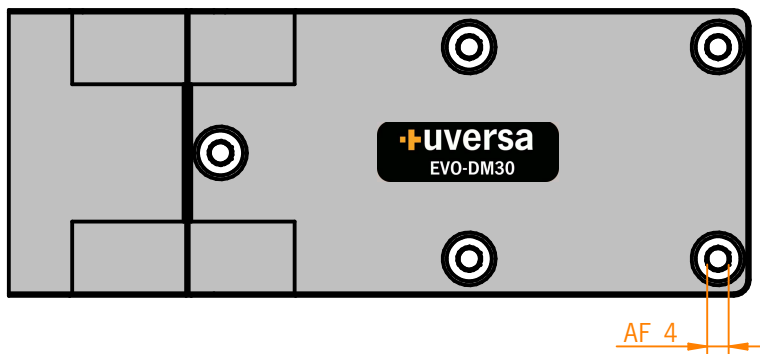

Customized items are available upon request.