

EVO-MM30
Mono-Module



TECHNICAL DETAILS

Material	Aluminium (ground)
Surface	● black, ● red, ● blue, ● green ● gold, ● ESD
Positional Tolerance Fitting Bores	± 0,01 mm
Positional Tolerance Bores	± 0,1 mm

MODULE DESCRIPTION

Module with fitting and mounting bores for precise lateral attachment of components in position. The two-piece structure enables the element quickly to be mounted to a single column system also at a later date.

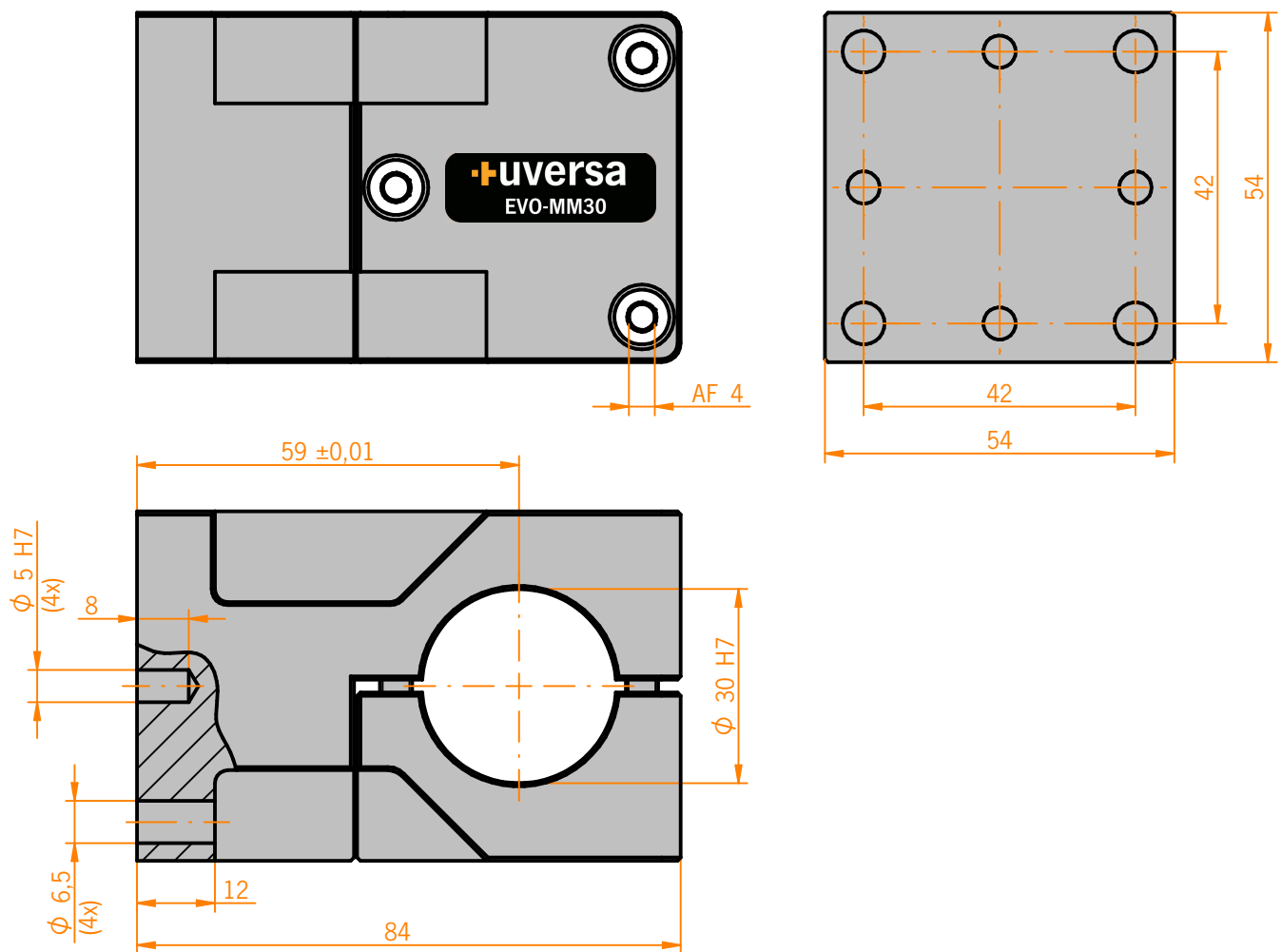

Customized items are available upon request.