

PEX-MS50
Mono-Pedestal



TECHNICAL DETAILS

Material	Aluminium (ground)
Surface	● black, ● red, ● blue, ● green ● gold, ● ESD
Positional Tolerance Fitting Bores	± 0,01 mm
Positional Tolerance Bores	± 0,1 mm

MODULE DESCRIPTION

Pedestal with fitting and mounting bores, acting as receptacle for one column. The item may be attached on working surfaces or integrated in assemblies.

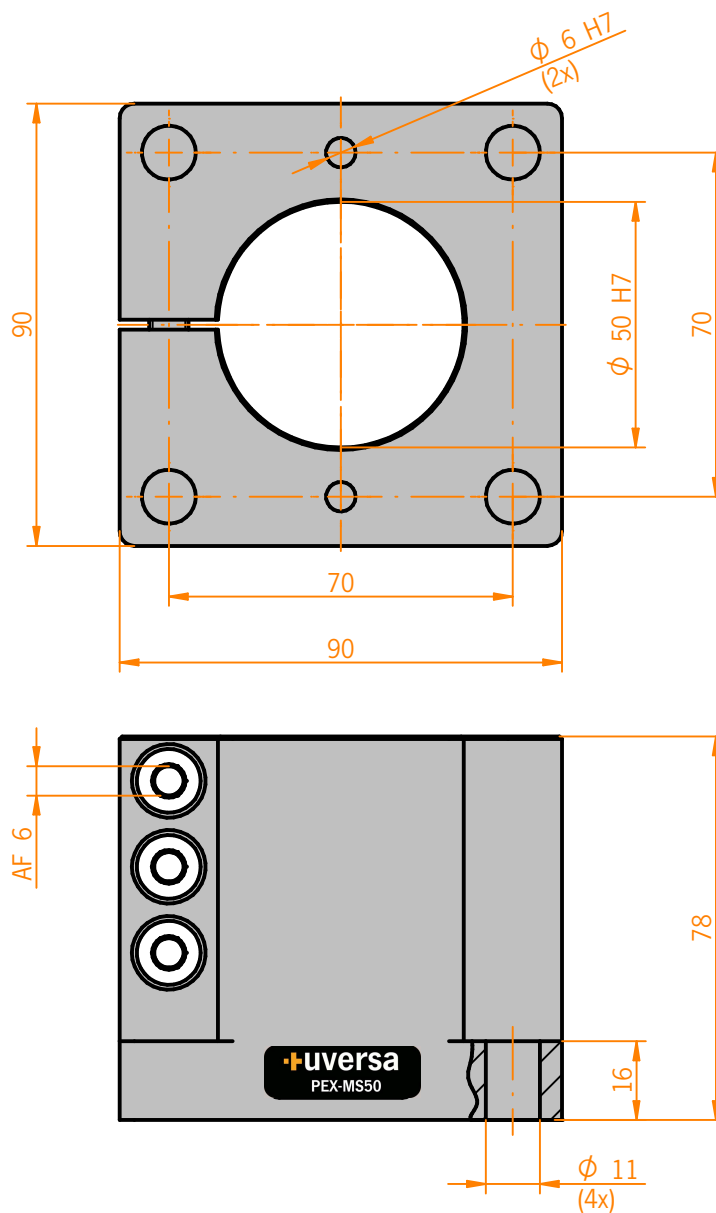

Customized items are available upon request.