

SENO-GV12 Hinged Connector

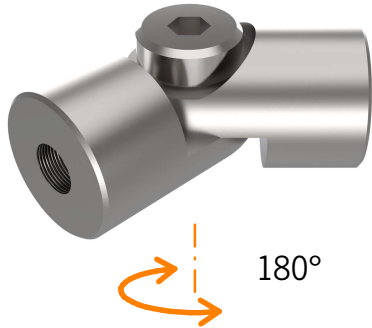

TECHNICAL DETAILS

Material Stainless Steel (1.4305)

Positional Tolerance $\pm 0,1$ mm

Bores

MODULE DESCRIPTION

By means of the intermediate hinge, two columns can be mutually oriented in any angle of up to $\pm 90^\circ$, infinitely variable.

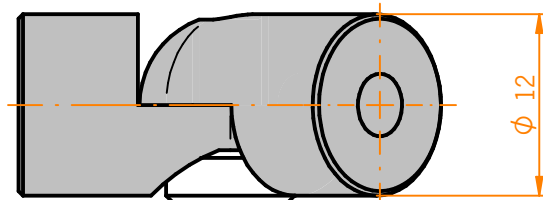
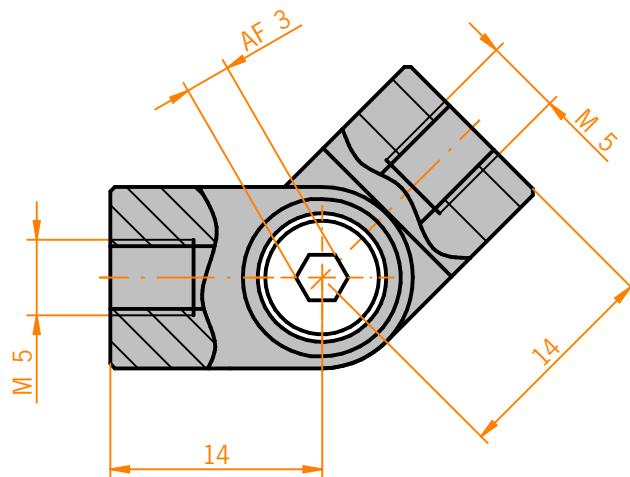

Customized items are available upon request.