

VIA-HS40
Hollow Column



TECHNICAL DETAILS

Weight	4'990g/m
Material	1.1213 (Cf53)
Surface	Ground, ends cut and chamfered
Treatment	Surface-hardened HRC 59+6

MODULE DESCRIPTION

Only few elements are required to realize a great variety of structural configurations, by means of these columns made of steel, induction hardened and ground.

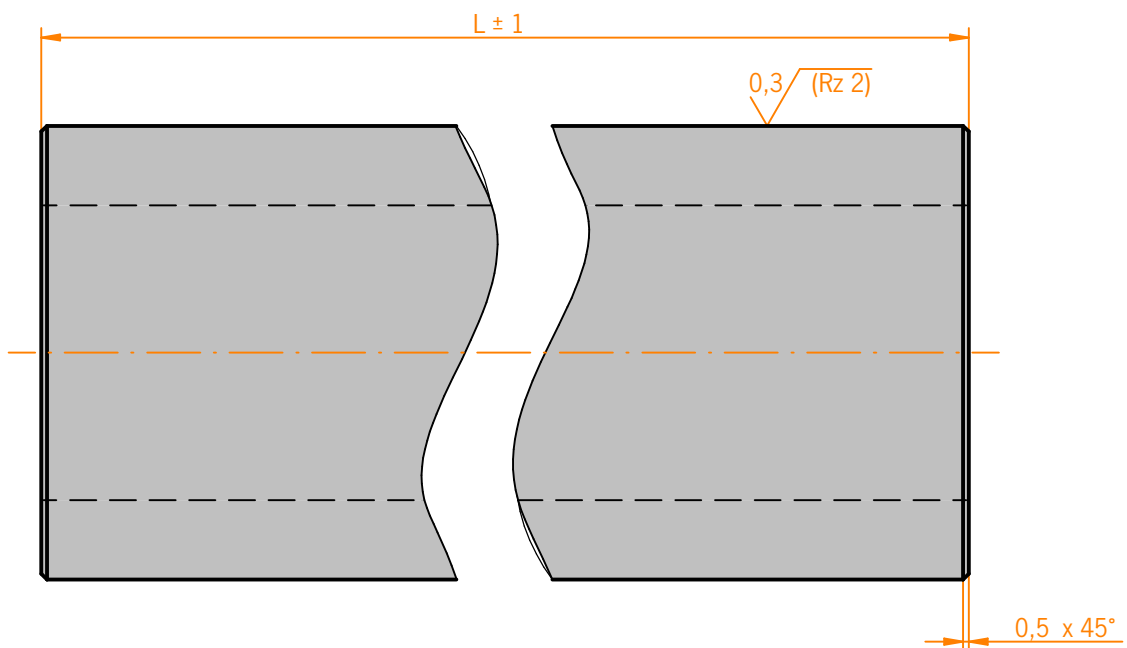
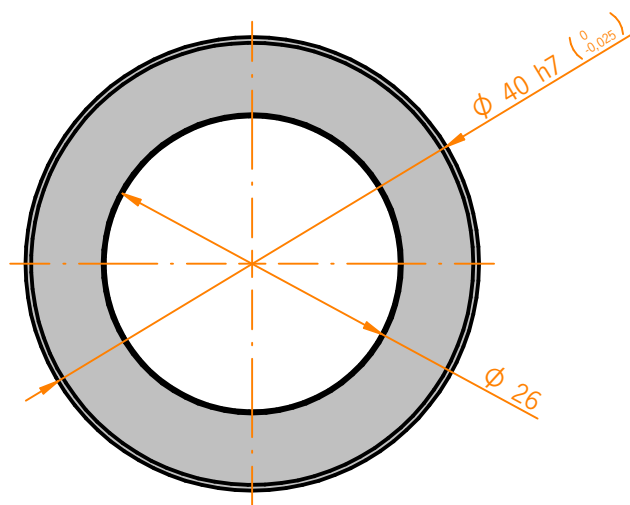

Customized items are available upon request.